

About this Manual

We've added this manual to the Agilent website in an effort to help you support your product. This manual is the best copy we could find; it may be incomplete or contain dated information. If we find a more recent copy in the future, we will add it to the Agilent website.

Support for Your Product

Agilent no longer sells or supports this product. Our service centers may be able to perform calibration if no repair parts are needed, but no other support from Agilent is available. You will find any other available product information on the Agilent Test & Measurement website, www.tm.agilent.com.

HP References in this Manual

This manual may contain references to HP or Hewlett-Packard. Please note that Hewlett-Packard's former test and measurement, semiconductor products and chemical analysis businesses are now part of Agilent Technologies. We have made no changes to this manual copy. In other documentation, to reduce potential confusion, the only change to product numbers and names has been in the company name prefix: where a product number/name was HP XXXX the current name/number is now Agilent XXXX. For example, model number HP8648A is now model number Agilent 8648A.

HP E4543A Q Factor and Eye Contours Application Software

Operating Manual

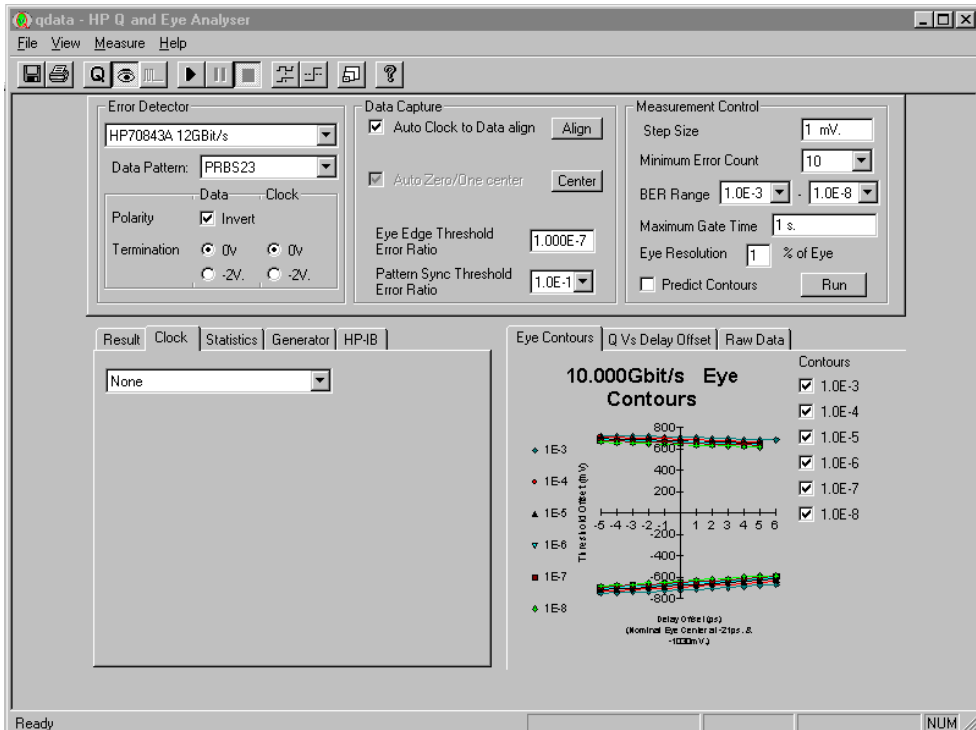

©Copyright Hewlett-Packard-Limited 1999

All rights Reserved.

Reproduction, adaption, or translation without prior written permission is prohibited, except as allowed under copyright laws.

Publication number

E4543-90004

Printed in UK

Notice

The information contained in this document is subject to change without notice.

Hewlett-Packard makes no warranty of any kind with regard to this material, including, but not limited to, the implied warranties or merchantability and fitness for a particular purpose.

Hewlett-Packard shall not be liable for errors contained herein or for incidental damages in connection with the furnishing, performance, or use of this material.

This manual was produced using *Doc-To-Help*[®], by WexTech Systems, Inc.

Microsoft[®] is the U.S. registered trademark of Microsoft Corporation
Lotus[®] is the U.S. registered trademark of Lotus Development Corporation

Contents

About the HP E4543A Q Factor and Eye Contour Application Software 1

Version Number	1
Overview	1

User Interface 3

Introduction	3
Menu Bar	3
File:	3
View:	4
Measure:	4
Help:	5
Tool bar	5
Status Bar	6
Application Window	6
To Select/Setup the Error Detector	6
To Setup Data Capture	7
To Setup Measurement Control	9
To Setup the Generator	11
To Setup the Clock	12
To Setup GPIB Address	13
To View Results:	14
To View Statistics	15
To View Warnings	16
Graphic Measurement Results	17

To Make a Measurement 19

Introduction	19
Q Factor Measurement Procedure	19
Setup Procedure	19
Eye Contour Measurement	23
Setup Procedure	23

Installation **27**

- Introduction 27
- Equipment Required 27
 - Supported Computer 27
 - HPIB Interface 27
- To Install E4543A Q Factor and Eye Application Software 28
 - Troubleshooting 28
 - Support 28

Legal Information **29**

- Warranty 29
- HP Software Product License Agreement 30

Reference **33**

- Introduction 33
- Derivation of Q 33
- Measurements method 37

About the HP E4543A Q Factor and Eye Contour Application Software

Version Number

A.02.00

Overview

The HP E4543A application software is designed to be used with Hewlett-Packard's HP 70843A/B and HP 70841B/70842B Error Performance Analyzers to enable users to characterize high speed optical communications links in terms of Q-factor and Eye Contour.

Measurement results can be displayed numerically or graphically, and also stored on disk or printed as required.

Q Factor explained

Q factor measurement is a technique for rapidly evaluating the quality of modern high performance optical communications systems. The Q factor measurement provides a single figure of merit related to the signal to noise ratio of the system under test.

Eye Contour explained

Eye Contour provides a graphical indication of the quality of the measured signal by plotting the Eye Diagram for various BER thresholds.

Reference

For a detailed explanation of Q Factor measurement techniques refer to Margin Measurements in Optical Amplifier Systems. IEEE Photonics Technology Letters Vol 5 number 3. N.S Bergano et al.

User Interface

Introduction

The Menu Bar, Tool Bar and keys within the application window are used to select main parameters and configure/control measurements. Refer to the following sections for an explanation of each of the user interfaces.

Menu Bar



The image shows a horizontal menu bar with four items: 'File', 'View', 'Measure', and 'Help'. Each item is underlined. The menu bar is set against a dark background with a blue highlight on the left side.

There are four selections on the Menu Bar, **File**, **View**, **Measure** and **Help**.

File:

Select from: **Save Data**, **Save Data As**, **Print Graph**, **Print Setup** and **Exit App**.

Save Data

Save the raw measurement data in ASCII format to a file (default extension .txt). Saved data can be loaded into an application such as Lotus 123[®] or Microsoft Excel[®] and processed to provide graphs/plots of measurement results. Note the ',' comma character is used as the separator between the fields in the .txt file.

Save Data As

Save data in a new or different file from the one initially selected.

Print Graph

Enables the **Print** dialog box where you can select the print functions.

Print Setup

Enables the **Print Setup** Dialog Box, which allows the user to change the Printer configuration. The detail may vary depending on the type of Printer configured on the PC.

Exit App

This selection exits the application window

View:

Select from **Tool Bar**, **Status Bar** and **Zoom**.

Tool Bar

Select **Tool Bar** to display all the application icons below the Menu Bar.

Status Bar

Select **Status Bar** to display current application status at the bottom of the application window.

Zoom

Select **Zoom** to enlarge the size of the graphs displayed in the application window.

Measure:

Select from: **Q Factor**, **Eye Contour**, **Burst Mode**, **Run**, **Pause**, **Stop**, **Align Clk/Data**, **Center 0/1** or **Frequency Update**.

Q Factor

Selecting this field selects measurement of Q.

Eye Contour

Selecting this field selects measurement of Eye Contours.

Burst Mode (HP 70843A/B only)

Select this mode when carrying out fibre optic loop tests.

Run

Starts a new measurement or continues a paused one.

Pause

Pauses the current measurement; selecting RUN will continue from where paused.

Stop

Stops the current measurement.

Align Clk/Data

Initiates a clock to data alignment attempt using the current instrument settings.

Center 0/1

Initiates a zero/one center operation using the current instrument settings

Frequency Update

Select this field to provide on the Results page a result of the measured frequency from the Error Detector.

Deselect the **Frequency Update** field (no tick next to selection) if you wish to set the HSBER instrument to Local and view or change displays.

Help:

About Q & Eye:

Use this key to view revision information for the E4543A Q Factor and Eye Contour application software.

Tool bar



Selects the Save As function; enables the Raw Data to be saved in ASCII format.



Prints the currently displayed graph. .



Selects measurement of Q.



Selects measurement of Eye Contours



Select Burst Mode Q measurement (HP 70843A/B only)



Starts a new measurement or continues a paused one



Pauses the current measurement; selecting RUN will continue from where paused



Stops the current measurement.



Performs a clock to data alignment attempt on the current measurement data.



Performs a zero/one center operation on the current measurement



Zoom: Use this icon to enlarge the display of the graphs (e.g. BER Vs Threshold) in the application window.



Help: Use this key to obtain revision information for the HP E4543A Q Factor and Eye Contour application software.

Status Bar

Status Bar

To enable the status bar select **VIEW** then **Status Bar**.

The four fields on the status bar give information on the current measurement.

Application Window

The following text illustrates and explains the user selectable functions and parameters within the HP E4543A Application window.

To Select/Setup the Error Detector

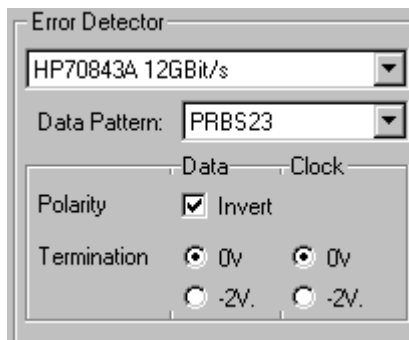

Select the Error Detector from the choices given. No other user selectable fields are enabled till you select an Error Detector. Initially values for all parameters are read from the Error Detector, and can be changed as required.

Data Pattern:

Select from a choice of PRBS patterns of **PRBS 7, 10, 15, 23** and **31** or select an **User Pattern** from **0** to **12**. User pattern 0 is the current user pattern. User patterns 1 to 4 are internal pattern stores in the instrument; patterns 5 to 12 are stored on disk.

Polarity:

Select data from normal or inverted.

Termination:

Click on the **Termination** buttons and set clock and data termination to **-2V** or **0V**.

To Setup Data Capture

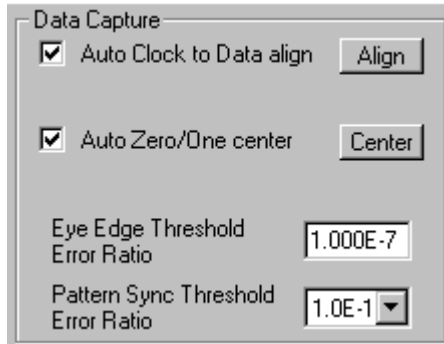

Initially values for all parameters are read from the Error Detector, and can be changed as required.

To Enable Automatic Clock to Data Alignment

Select **Auto Clock to Data align** with the left mouse button. If **Auto Clock to Data Align** is selected when a measurement is run the measurement will perform a clock to data alignment before proceeding. If **Auto Clock to Data Align** is not selected a data entry control is available to allow the user to specify a required **Clock to Data delay**.

To Perform an Automatic Clock to Data alignment

First enable **Automatic Clock to Data Alignment** then click on the adjacent **Align** button or the clock to data align button in the Toolbar.

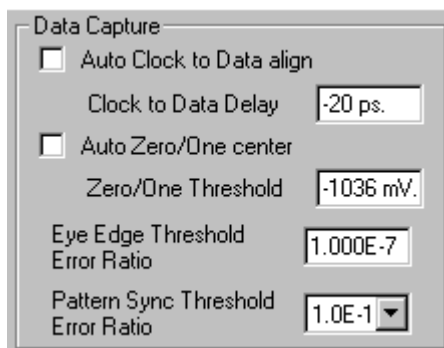

To Set Clock to Data Delay

Deselect **Auto Clock to Data align** and then click on the **Clock to Data Delay** box and set the delay as required. Default values are read from the Error Detector. This selection is only available when there is no clock to data alignment selected in Q or Eye Contour measurements.

To Enable Automatic Zero/One Centering

Select Auto Zero/One Center with the left mouse button. If Automatic 0/1 centering is selected when a measurement is run the measurement will perform a Zero/One Center operation before proceeding, after clock/data alignment is selected. If Automatic 0/1 Centering is not selected a data entry control is available to allow the user to specify a desired Zero/One center threshold.

To Perform the Zero/One Center

First enable Automatic 0/1 Centering then click on the adjacent Center button or on the 0/1 center button in the Toolbar.

To Set the Zero/One Center

Deselect **Auto Zero/One center** and then click on the **Zero/One Threshold** box and set the Threshold as required. The default values are read from the Error Detector. This selection is only available when there is no Auto Zero/One center selected.

To Set Eye Edge Threshold Error Ratio

Click in the Eye Edge Threshold Error Ratio data entry control and enter the eye edge threshold error ratio as required using the keys provided.

To Select Pattern Sync Threshold Error Ratio

Click in the Pattern Sync Threshold Error Ratio data entry control and enter the pattern sync threshold error ratio as required using the keys provided.

To Select Burst Mode Duty Cycle

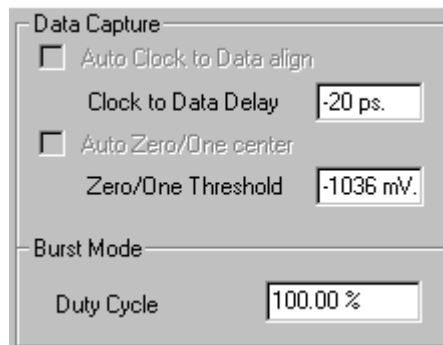

The image shows a dialog box with two sections. The top section is titled "Data Capture" and contains two checkboxes. The first checkbox is "Auto Clock to Data align" and is unchecked. Below it is a text field labeled "Clock to Data Delay" with the value "-20 ps.". The second checkbox is "Auto Zero/One center" and is also unchecked. Below it is a text field labeled "Zero/One Threshold" with the value "-1036 mV.". The bottom section is titled "Burst Mode" and contains a text field labeled "Duty Cycle" with the value "100.00 %".

This function is only available when a Q measurement is selected, and the Error Detector is an HP 70843A/B. Click on the Burst Mode icon or

select Burst Mode from the Measure menu, then click in the Duty Cycle data entry control and enter the measurement duty cycle as required using the keys provided.

To Setup Measurement Control

Measurement Control

Step Size 1 mV.

Minimum Error Count 10

BER Range 1.0E-5 - 1.0E-10

Maximum Gate Time 13 s.

Continuous Repeat Run

To Select 0/1 Threshold Step Size

Click on the **Step Size** box and set the value as required. For measurements where the eye quality is poor and many data points are being collected it may be appropriate to increase the 0/1 threshold step size.

To Select Minimum Error Count

Click on the **Minimum Error Count** box and select a value of **10**, **100** or **1000**.

To Select BER Range

Click on the **BER Range** boxes and select maximum and minimum BER limits for the measurement. Recommended default values are:
Q Measurement 1.0E-5, 1.0E-10 and
Eye Contours 1.0E-3, 1.0E-10.

Q is calculated with data in the selected range, i.e. range affects Q factor and predicted contours in Eye Mode.

To Select the Maximum Gate Time

Click on the **Maximum Gate Time** box and use the keys provided to select a value. The optimum maximum gate time is automatically set based on the current user selections of Minimum Error Count, BER, and the measured input data rate and Burst Mode duty cycle. If you

select a gate time of your own choice a warning may be displayed on the screen if it is less than the calculated value.

To Select a Single or Continuous Repeat Measurement

Click on the **Continuous Repeat** box and select as required. If you select **Continuous Repeat** (an [✓] in the box) a new measurement begins at the end of each measurement. Note that this function is only available in Q Factor application.

When Continuous Repeat is selected the Q Vs Time and QPDF pages become available.

To Select Eye Resolution

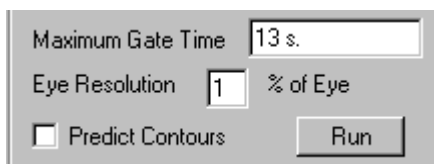

The screenshot shows a control panel with the following elements:

- A text label "Maximum Gate Time" followed by a text input field containing "13 s."
- A text label "Eye Resolution" followed by a text input field containing "1" and a label "% of Eye".
- A checkbox labeled "Predict Contours" which is currently unchecked.
- A button labeled "Run".

Click on the **Eye Resolution** box and select the required delay step size as a percentage of the bit period. Note this function is only available in the Eye Contour application.

To Predict Contours

Select [✓] in the box to enable the Predict Contours function. Note this function is only available in the Eye Contour application, and will attempt to calculate contours down to 1E-20.

Enabling Contours prediction will result in the display of contours beyond the measured range based on Q results calculated at each delay. If, for any reason a Q result is not calculated at a particular clock to data delay then no predicted contours are displayed at that delay point.

To Initiate a Q or Eye Measurement

Click on **RUN**.

To Setup the Generator

Result | Clock | Statistics | **Generator** | HP-IB

HP70843A 12GBit/s

Pattern: PRBS23

	Data	Clock
Polarity:	<input type="checkbox"/> Invert	
Termination:	<input type="radio"/> AC <input checked="" type="radio"/> DC 0V <input type="radio"/> DC -2V	<input type="radio"/> AC <input checked="" type="radio"/> DC 0V <input type="radio"/> DC -2V
Amplitude:	2.000V	0.500V
High Level:	0.000V	0.250V

Data Delay: 0 ps.

Click on the Generator tab and setup as required, using the keys provided.

Initially values for all parameters are read from the Pattern Generator, and can be changed as required. The 3Gb/s Pattern Generator can operate in master or slave mode, if you require advice on Master/Slave operation refer to chapters 6 and 7 of the HP 71600B Installation and Verification manual (part number 71600-90005).

The following Note applies to the HP 70843A/B only: -

Note: The application software only controls **Data** and **Clock** outputs. It does not control **Not Data** and **Not Clock** on the HP 70843A/B (unless tracking is enabled).

Pattern

Select from a choice of PRBS patterns of **PRBS 7, 10, 15, 23** and **31** or select a **User Pattern** from **0** to **12**. User pattern 0 is the current user pattern. User patterns 1 to 4 are internal pattern stores in the instrument; patterns 5 to 12 are stored on disk.

Note the Generator **Pattern** field is not user selectable if the Error Detector configures the Generator Pattern, the Generator Pattern is then set by the Error Detector selection. For example the **Pattern** field is *grayed out* when an HP 70843A/B Error Detector and Pattern Generator are used; but it is not grayed out if an HP 70843A/B Error Detector and an HP 70841A Pattern Generator are used.

Polarity

Select from normal or inverted.

Termination

Set **Data** and **Clock** Termination to **AC** (HP 70843A/B only) or **DC - 2V / 0V**.

Amplitude

Click on the appropriate data entry control and enter the **Data** and **Clock** Amplitude to the required value using the keys provided.

High Level

Click on the appropriate data entry control and enter the **Data** and **Clock** High Level to the required value using the keys provided

Data to Clock Delay



Data Delay: ps.

Set the generator data to clock delay by clicking on the **Data to Clock Delay** box and using the keys provided to select the required value.

To Setup the Clock

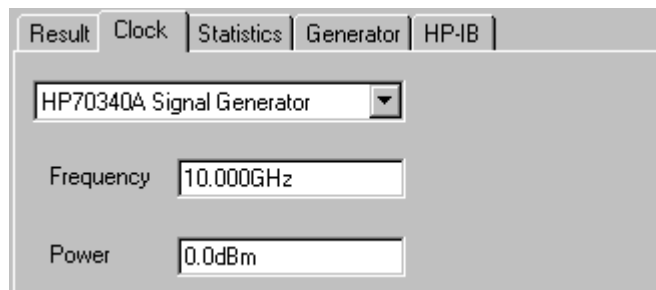

Result | **Clock** | Statistics | Generator | HP-IB

HP70340A Signal Generator

Frequency: 10.000GHz

Power: 0.0dBm

Click on the **Clock** tab and select the clock source using the keys provided. If you require information on Master/Slave operation refer to your Error Performance Analyzer Operating manual.

Frequency

Click on the frequency key and set the frequency as required.

Power (HP 70340A only)

Click on the Power key and set the power as required.

Warning: Do not set the power level greater than the maximum input power level of the HP 70843A/B (15dBm).

To Setup HPIB Address

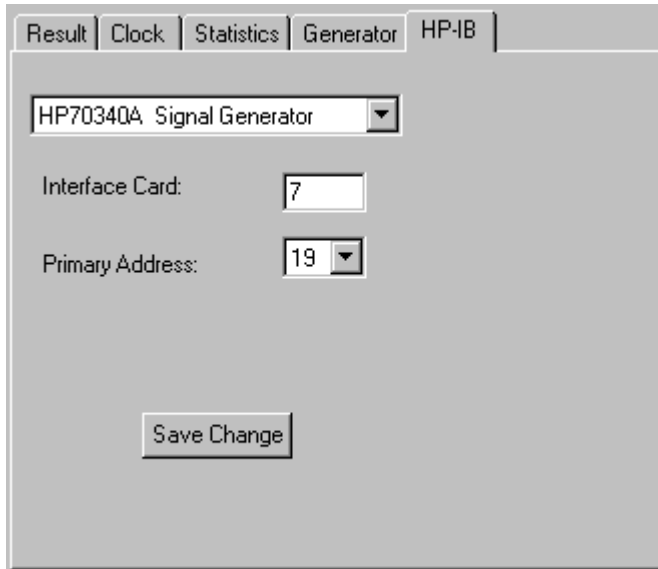

The screenshot shows a software window titled "HP-IB" with several tabs: "Result", "Clock", "Statistics", "Generator", and "HP-IB". The "HP-IB" tab is selected. Inside the window, there is a dropdown menu showing "HP70340A Signal Generator". Below this, there are two input fields: "Interface Card:" with a text box containing the number "7", and "Primary Address:" with a dropdown menu showing "19". At the bottom of the window is a "Save Change" button.

Click on the HPIB tab and then select the Primary address for the instrument selected. Note that the Secondary Address is not applicable for HP Error Performance Analyzers.

For Interface Cards set to a select code other than 7 (default), change the "7" in the Interface Card text box to the required number.

Default HPIB Primary Addresses are as follows:

HP 70843A/B - 18; HP 70340A - 19.

HP 70841B - 18, HP 70842B - 17.

HP 70311A - 19.

To View Results:

Result	Clock	Statistics	Generator	HP-IB
TIME:	Wed Sep 01 11:00:01 1999			
DATA:	10.000Gbit/s	PRBS23		
Clock to Data Delay:		-20ps.		
Eye Size:		1295mV.	64ps.	
Edge Threshold:		1.00E-7		
Q Factor:		34.0 (30.6dB)		
Predicted Optimum		-918.0mV.		
BER		2.5E-254		
Threshold Spread:				
Zeros		33mV	Ones	22mV
Detector Serial No		GOLDSTDLPB		

Click on the **Results** tab in the lower left-most portion of the application window to view the following results:

- TIME: records the time and date of the last measurement.
- DATA: gives the data rate and pattern.
- Error Detector Clock to Data Delay in ps - (results of clock to data align in auto align mode).
- Eye Size width (in mv) and height of eye (in ps.), bounded by the error rate defined by the Eye Edge Threshold.
- Eye Edge Threshold.
- Q or Eye results information (depending on current measurement).

To View Statistics

	Zeros	Ones
Points Measured	34	23
Mean Data Level	-1.8V	-287.1mV
Std Deviation	26.2mV	18.5mV
Coeff of Determ'	99.9%	98.3%

Warnings will be given if the following conditions are not met:

Max Freq Variation (MHz)

Minimum points measured

Q Coeff of Determination

Minimum error count

Warnings Timeout in Continuous Mode

Click on the Statistics tab to view the statistical results relating to the calculation of Q.

The Statistical results displayed are:

Points Measured

The number of points measured that fall within the BER range limits. These are the data points upon which the linear regressions are performed as part of the Q calculation.

Mean Data Level

The calculated mean level of the zero and one pulses derived from the Inverse Error Function assuming that the sampled points form part of gaussian distributions around the means.

Standard Deviation

The calculated standard deviation of the zero and one pulses derived from the Inverse Error Function assuming that the sampled points form part of gaussian distributions around the means.

Coefficient of Determination

The Coefficient of Determination provides an indication of the quality of the linear regression best line fit used as part of the Q calculation. As such these results provide an indirect indication of the reliability of the Q result.

To View Warnings

	Zeros	Ones
Points Measured	34	23
Mean Data Level	-1.8V	-287.1mV
Std Deviation	26.2mV	18.5mV
Coeff of Determ'	99.9%	98.3%

Warnings will be given if the following conditions are not met:

Max Freq Variation (MHz)

Minimum points measured

Q Coef of Determination

Minimum error count

Warnings Timeout in Continuous Mode

Click on the **Statistics** tab to view the user selectable warnings.

Maximum Frequency Variation (MHz)

This warning only applies to Continuous Q measurements and Eye measurements. The Maximum Frequency Variation setting is the amount by which the clock frequency is allowed to vary from its initial setting before a warning is displayed.

If the clock frequency varies by an amount greater than the value selected (in the Maximum Frequency Variation field) the measurement is suspended and a warning is displayed. The warning offers the choice of continuing with the measurement (click OK) or aborting (click CANCEL).

If you select OK the measurement continues, however the results may be inaccurate.

If you select CANCEL; reset the clock source as required or change the Maximum Frequency Variation to a more suitable value before starting a new measurement.

Eye Edge Minimum points measured

This facility provides a means of alerting the user if a Q calculation would be based on too few measured points. In order for the Q factor calculation to be valid sufficient points must be measured on each side of the Zero/One center to allow the necessary linear regression calculation to be valid. The more points that are used the greater the confidence in the calculated results.

A warning will be given if fewer than the given number of points are measured on either side of the Zero/One center.

If Continuous Repeat is selected this warning will time-out to allow repetition to continue.

Q Coefficient of Determination

The Coefficient of Determination is a statistical indication of the validity of the linear regressions performed as part of the Q calculation. This facility provides a means of alerting the user if a Q calculation would be based on linear regression results with less than the requested Determination.

A warning will be given if the requested Coefficient of Determination is not achieved for either side of the Zero/One center.

If Continuous Repeat is selected this warning will time-out to allow repetition to continue.

Minimum Error Count not reached during gate time

If you select this box a warning will be displayed on the screen if the **Minimum Error Count** value (selected in the Measurement Control box) is not achieved within the **Maximum Gate Time** (selected in the Measurement Control box).

If Continuous Repeat is selected this warning will time-out to allow repetition to continue.

Graphic Measurement Results

Graphic Displays of the following statistical results are displayed:

Q Factor Measurement

When a **Single Q** measurement is performed displays of BER versus Threshold, Inverse Error Function versus Threshold and Raw Data are provided.

When **Continuous Repeat** is selected for Q measurements, additional graphs for Q versus time and Q PDF displays are provided.

Eye Contour Measurement

Graphical displays of Eye Contours, Q Factor versus Delay and Raw Data are provided.

To Make a Measurement

Introduction

The following procedure explains how to configure the HP E4543A Q Factor and Eye Contour Application Software to perform Q factor and Eye Contour measurements when using a HP Error Performance Analyzer. It is recommended that you configure the measurements in the order given.

Before running the application software ensure that the Error Performance Analyzer has been powered up for at least 30 seconds and is functioning correctly.

Q Factor Measurement Procedure

This procedure assumes the software is loaded correctly and the HP Error Performance Analyzer and your PC are connected via an HPIB cable, and configured correctly.

Setup Procedure

Setup Clock Source

1. Set your clock source to the desired frequency.

Setup Pattern Generator

2. If your system includes a Pattern Generator click on the first field within the Generator functional box and select a Pattern Generator from the choices given.
3. Setup the Pattern Generator **Pattern**, **Polarity**, **Termination**, **Amplitude** and **High Level** as required.

Setup Error Detector

4. Click on the top field within the **Error Detector** functional box and select an Error Detector from the choices given.

5. Select the **Q Measure** icon from the Tool Bar or select **Measure, Q Factor** from the Menu Bar.
6. Select a **Data Pattern** - the choices are PRBS of 7, 10, 15, 23 or 31 or User Patterns 0 to 12. User pattern 0 is the current data pattern.
7. Select **Data Polarity** - choose from **normal** or **inverted**.
8. Select **Data** and **Clock Termination** - set to 0V or -2V.

Setup Data Capture

9. The default setting for **Auto Clock to Data Align** and **Auto Zero/One center** is ON (an [x] in the box), which is the recommended setting.
If you wish to set your own **clock to data delay** or **zero/one threshold** deselect the appropriate boxes (or if you are in Burst Mode) and select the required values using the keys provided.
10. In **Burst Mode** select a duty cycle 100% to 0.01%. Note this does not set the pulse generator but is used to determine the maximum gate time.
11. If you are not in Burst Mode select the required **Eye Edge Threshold Error Ratio**.
12. If not in Burst Mode select the **Pattern Sync Threshold**, the range is 1.0E-1 to 1.0E-8.

On continuous run measurements it may be advisable to perform clock to data align and zero/one center operations first, and then deselect auto clock to data align and zero/one center, before running a measurement.

Setup Measurement Control

13. Select the **0/1 Threshold Step Size**. For long duration measurements you may need to increase the step size to a suitable value.
14. Select the **Minimum Error Count**, the choices are **10**, **100** or **1000**. This selection can determine the duration of the measurement. If you select for example an error count of 100, then each data point is sampled until either 100 errors occur or the maximum gating time is exceeded. The 10 selection is the fastest but the least accurate.
15. Select the **BER Range** from 1.0E-1 to 1.0E-12. Note: Set the maximum rate consistent with at least 1 error/tenth second is as follows:
At 3 Gb/s: 10 errors/second = 3.3E-9
At 10 Gb/s 0.1% Burst = 1.0E-6.
Recommended default setting is 1.0E-5 to 1.0E-10.

16. **Maximum Gate Time** - Before you select the Maximum Gate Time please read the following note.
Note: The optimum Maximum Gate Time is automatically set for the user based on the current selections. This setting is determined by the following user selections: Minimum Error Count, BER Range, measured data rate (and the burst mode duty cycle). It is recommended therefore that you setup the measurement in the order given. If you wish to select another Gate Time use the keys provided. Warnings may be displayed on the screen if your choice is less than a preferred value.
17. Select a **Single** or **Continuous** measurement. If you select Continuous then at the end of each measurement-gating period a new measurement begins.

Statistics

To Set Maximum Frequency Variation

18. This warning only applies to Continuous Q measurements and Eye measurements. The Maximum Frequency Variation setting is the amount by which the clock frequency is allowed to vary from its initial setting before a warning is displayed. Click on the **Max Freq Variation** field and set as required.

If the clock frequency varies by an amount greater than the value selected (in the Maximum Frequency Variation field) the measurement is suspended and a warning is displayed. The warning offers the choice of continuing with the measurement (click OK) or aborting (click CANCEL). Note the clock frequency is checked at the beginning of each Q measurement.

If you select OK the measurement continues, however the results may be inaccurate.

If you select CANCEL; reset the clock source as required or change the Maximum Frequency Variation to a more suitable value before starting a new measurement.

To Set Eye Edge Points Measured Warning

19. This facility provides a means of alerting the user if a Q calculation would be based on too few measured points. In order for the Q factor calculation to be valid sufficient points must be measured on each side of the Zero/One center to allow the necessary linear regression calculation to be valid. The more points that are used the greater the confidence in the calculated results.
A warning will be given if less than the given number of points is measured on either side of the Zero/One center.

If Continuous Repeat is selected this warning will time-out to allow repetition to continue.

To Set Q Coefficient of Determination Warning

20. The Coefficient of Determination is a statistical indication of the validity of the linear regressions performed as part of the Q calculation. This facility provides a means of alerting the user if a Q calculation would be based on linear regression results with less than the requested Determination.

A warning will be given if the requested Coefficient of Determination is not achieved for either side of the Zero/One center.

If Continuous Repeat is selected this warning will time-out to allow repetition to continue.

To Select Minimum Error Count Warning

21. User selectable to On [x] or OFF []. Set this field to ON [x] if you wish a warning displayed whenever the minimum error count is not reached within the maximum gate time.

To Start a New Measurement

22. Select **Run** to start a new measurement. As the measurement progresses status messages are displayed in the Status Bar and the graphs results are updated as data is measured.

The measurement sequence is as follows:

- a. Perform Clock to Data Alignment (if Auto selected).
- b. Perform 0/1 Threshold center (if Auto selected).
- c. Search for Zero Edge on eye.
- d. Collect BER Vs Threshold at Zero edge over specified BER range.
- e. Search for One edge.
- f. Collect BER Vs Threshold at One edge over specified BER range
- g. Perform Q calculation and display result.

Results

23. Click on the Results tab to view results of Clock to Data delay, 0/1 Threshold center and eye width and height.

Graphs are given of BER versus Threshold, Inverse Error Function versus Threshold showing straight line fit and a numerical display of Raw Data is also available.

When **Continuous Repeat** is selected in the **Measurement Control** data entry box graphs of Q Vs Time and Q PDF are also provided.

In **Continuous Repeat** mode the results displayed are the results from the last complete measurement.

At the end of the measurement the Results window also shows:
Q factor (linear/dB).
Optimum 0/1 threshold
Residual BER at optimum 0/1 threshold
Threshold spread (number of millivolts between
maximum/minimum specified BER).

24. Return to the Statistics window to get the following:
The number of points measured for ones and zeros.
The mean data levels.
A calculation of the Std Deviations, and the Coefficients of
Determination from the linear regression.

Eye Contour Measurement

This procedure assumes the software is loaded correctly and the HP Error Performance Analyzer and your PC are connected via an HPIB cable, and configured correctly.

Setup Procedure

Setup Clock Source

1. Set your clock source to the desired frequency.

Setup Generator

2. If your system includes a Pattern Generator click on the first field within the Generator functional box and select a Pattern Generator from the choices given.
3. Setup the Pattern Generator **Pattern, Polarity, Termination, Amplitude** and **High Level** as required.

Setup Error Detector

4. Click on the top field within the **Error Detector** functional box and select an Error Detector from the choices given.
5. Select the Eye Contour icon from the Tool Bar or select **Measure, Eye Contour** from the Menu Bar
6. Select a **Data Pattern** - the choices are PRBS of 7, 10, 15, 23 or 31 or User Patterns 0 to 12. User pattern 0 is the current data pattern.
7. Select **Data Polarity**.

8. Select **Data** and **Clock Termination**.

Setup Data Capture

9. The default setting for Auto Clock to Data Align is ON (an [x] in the box), which is the recommended setting.
If you wish to set your own **clock to data delay** deselect the appropriate box and select the required values using the keys provided.
10. Select the required **Eye Edge Threshold Error Ratio**.
11. Select **Pattern Sync Threshold**, the range is 1.0E-3 to 1.0E-8.

Setup Measurement Control

12. Select the **0/1 Threshold Step Size**. For long duration measurements you may need to increase the step size to a suitable value.
13. Select the **Minimum Error Count**, the choices are 10, 100 or 1000. This selection can determine the duration of the measurement. If you select for example an error count of 100, then each data point is sampled until either 100 errors occur or the maximum gating time is exceeded. The 10 selection is the fastest but least accurate.
14. Select the **BER Range** from 1.0E-1 to 1.0E-12. The recommended default setting is 1.0E-3 to 1.0E-10.
15. **Maximum Gate Time** - Before you select the Maximum Gate Time please read the following Note:
Note: The optimum Maximum Gate Time is automatically set for the user based on the current selections. This setting is determined by the following user selections: Minimum Error Count, BER Range and the measured data rate. It is recommended therefore that you setup the measurement in the order given. If you wish to select another Gate Time use the keys provided. Warnings may be displayed on the screen if your choice is less than a preferred value.
16. **Eye Resolution**: Click on the **Eye Resolution** box and select the required delay step size.
17. **Predict Contours**:
If you select **Predict Contours** the application will attempt to predict the eye contours down to a BER of 1.0E-20 at each sample delay based on the Q calculation at that delay.

Statistics

To Set Maximum Frequency Variation

18. This warning only applies to Continuous Q measurements and Eye measurements. The Maximum Frequency Variation setting

is the amount by which the clock frequency is allowed to vary from its initial setting before a warning is displayed. Click on the **Max Freq Variation** field and set as required.

If the clock frequency varies by an amount greater than the value selected (in the Maximum Frequency Variation field) the measurement is suspended and a warning is displayed. The warning offers the choice of continuing with the measurement (click OK) or aborting (click CANCEL). The clock frequency is checked at the start of each delay step.

If you select OK the measurement continues, however the results may be inaccurate.

If you select CANCEL, reset the clock source as required or change the Maximum Frequency Variation to a more suitable value before starting a new measurement.

To Set Eye Edge Points Measured Warning

19. This facility provides a means of alerting the user if a Q calculation would be based on too few measured points. In order for the Q factor calculation to be valid sufficient points must be measured on each side of the Zero/One center to allow the necessary linear regression calculation to be valid. The more points that are used the greater the confidence in the calculated results.
A warning will be given if less than the given number of points is measured on either side of the Zero/One center.
If Continuous Repeat is selected this warning will time-out to allow repetition to continue.

To Set Q Coefficient of Determination Warning

20. The Coefficient of Determination is a statistical indication of the validity of the linear regressions performed as part of the Q calculation. This facility provides a means of alerting the user if a Q calculation would be based on linear regression results with less than the requested Determination.
A warning will be given if the requested Coefficient of Determination is not achieved for either side of the Zero/One center.

To Select Minimum Error Count Warning

21. User selectable to On [x] or OFF []. Set this field to ON [x] if you wish a warning displayed whenever the minimum error count is not reached within the maximum gate time.

To Start a New Measurement

22. Select **Run** to start a new measurement.
As the measurement progresses status messages are displayed in the Status Bar and the graphs results are updated as data is measured.
The measurement sequence is as follows:
 - a. Perform Clock to Data Alignment (if Auto selected).
 - b. Perform 0/1 Threshold Center.
 - c. Search for zero edge of eye.
 - d. Collect BER Vs Threshold at zero edge.
 - e. Search for One edge of eye.
 - f. Collect BER Vs Threshold.
 - g. Calculate Q - if valid Q calculated then plot the predicted contours.
 - h. Step clock to data delay by the size of the preset eye resolution (e.g. 10%) and repeat from step c.

Results

23. Click on the Results tab to view results of Clock to Data delay, Eye Size, Eye Edge Threshold, and Nominal Eye Center. Graphs are given of Eye Contours, Q versus Delay and a numerical display of Raw Data is also provided. At each delay step the Results window also shows:
 - Q factor (linear/dB).
 - Optimum 0/1 threshold.
 - Residual BER at optimum 0/1 threshold.
 - Threshold spread (number of millivolts between maximum/minimum specified BER).
24. Return to the Statistics window to get the following:
 - The number of points measured for ones and zeros.
 - The mean data levels.
 - A calculation of the Std Deviations, and the Coefficients of Determination from the linear regression.

Installation

Introduction

This chapter provides information on the equipment required to run the E4543A Q Factor and Eye Contour Application Software and how to install it. Simple troubleshooting is also given to aid the user should the application fail to operate correctly and advice on where to obtain additional support.

Equipment Required

HP Error Performance Analyzer

To enable back to back operation a Pattern Generator is required.

Supported Computer

The E4543A Q Factor and Eye Contours Application Software is designed to run on IBM-PC/AT, or 100% compatible, PC or Laptop running Microsoft Windows 95 or Microsoft Windows NT.

The recommended and supported PC options are:

HP 100MHz Pentium PC with at least 8 Mbytes of memory and a HP 82335B interface, or HP 82341C. Note that the E4543A software cannot be used with the HP 82341D interface.

The E4543A application software is supplied on two 3.5in floppy disks.

HPIB Interface

Control of the HP Error Performance Analyzer from the computer is via the IEEE.488 interface (HPIB).

The HP standard Instrument Control Library (SICL) is used as the interface between the application software and the HPIB hardware.

Note: HP SICL does not form part of the E4543A product and must be installed separately before the application can run.

The recommended interface is the HP 82341C with HP E2094G I/O libraries.

The HP E4543A is a 16-bit application and requires 16-bit SICL drivers to be installed.

To Install E4543A Q Factor and Eye Application Software

1. Ensure an HPIB card is installed in your PC and is configured correctly.
2. Connect a suitable cable from the HP Error Performance Analyzer rear panel HPIB port to the HPIB port on your PC.
3. Run the File Manager.
4. Insert disk 1 into the "A" floppy disk drive.
5. In **File Manager** select drive "A".
6. Select and run file "setup.exe".
7. Follow the installation instructions that appear on your screen after installation.
8. To run the software click on the Q & Eye Analyzer under the Windows Start/Programs menu.
9. To run the help file click on the Q & Eye Help icon under the Windows Start/Programs menu.

Troubleshooting

If the E4543A application software is not operating properly or not at all, carry out the following procedure:

1. Check that the HP Error Performance Analyzer is powered up correctly.
2. Check that the HP Error Performance Analyzer and the PC HPIB ports are cabled together
3. Check that the HPIB card installed in your PC is configured correctly. Use the I/O Config Utility in the HP SICL program group.
4. Ensure the HPIB address of each element in your system is set correctly.

Support

If you need any further help, please contact your nearest Hewlett-Packard service center or fax details to the Hewlett Packard Product Support department:

+44 131 331 7488.

Legal Information

Warranty

Software: HP warrants for a period of 90 days from the date of purchase that the software product will execute its programming instructions when properly installed on the personal computer or workstation indicated on this package. HP does not warrant that the operation of the software will be uninterrupted or error free. In the event that this software product fails to execute its programming instructions during the warranty period, Customer's remedy shall be to return the diskette(s) or tape cartridge(s) ("media") to HP for replacement. Should HP be unable to replace the media within a reasonable amount of time, Customer's alternate remedy shall be a refund of the purchase price upon return of the product and all copies.

Media: HP warrants the media upon which this product is recorded to be free from defects in materials and workmanship under normal use for a period of 90 days from the date of purchase. In the event any media prove to be defective during warranty period, Customer's remedy shall be to return the media to HP for replacement. Should HP be unable to replace the media within a reasonable amount of time, Customer's alternate remedy shall be a refund of the purchase price upon return of the product and all copies.

Notice of Warranty Claims: Customer must notify HP in writing of any warranty claim not later than thirty (30) days after the expiration of the warranty period.

Limitation of Warranty: HP makes no other express warranty, whether written or oral, with respect to this product. Any implied warranty of merchantability or fitness is limited to the 90-day duration of this written warranty. Some states or provinces do not allow limitations on how long an implied warranty lasts, so the above limitation or exclusion may not apply. *

This warranty gives specific legal rights, and you may also have other rights that vary from state to state, or province to province.

Exclusive Remedies: The remedies provided above are Customer's sole and exclusive remedies. In no event shall HP be liable for any direct, indirect, special, incidental, or consequential damages (including lost

profit) whether based on warranty, contract, tort, or any other legal theory. Some states or provinces do not allow the exclusion or limitation of incidental or consequential damages, so the above limitation or exclusion may not apply to you.

Warranty Service: Warranty service may be obtained from the nearest HP sales office or other location indicated in the owner's manual or service booklet.

* UK only: if you are a "customer" as defined by statutes, parts of this statement may not apply to you.

HP Software Product License Agreement

Important: Please carefully read this license Agreement before opening the media envelope or operating the equipment. Rights in the software are offered only on the condition that the Customer agrees to all terms and conditions of the License Agreement. Opening the media envelope or operating the equipment indicates your acceptance of these terms and conditions. If you do not agree to the License Agreement, you may return the unopened package for a full refund.

License Agreement

In return for payment of the applicable fee, HP grants the Customer a license in the software, until terminated, subject to the following:

Use

Customer may use the software on any one computer.

Customer may not reverse assemble or decompile the software.

Copies and Adaptations

Customer may make copies or adaptations of the software:

For archival purposes, or

When copying or adaptation is an essential step in the use of the software with a computer so long as the copies and adaptations are used in no other manner.

Customer has no rights to copy unless they acquire an appropriate license to reproduce which is available from HP for some software.

Customer agrees that no warranty, free installation, or free training is provided by HP for any copies or adaptations made by Customer.

All copies and adaptations of the software must bear the copyright notice(s) contained in or on the original.

Ownership

Customer agrees that they do not have any title or ownership of the software, other than ownership of the physical media.

Customer acknowledges and agrees that the software is copyrighted and protected under the copyright laws.

Customer acknowledges and agrees that the software may have been developed by a third party software supplier named in the copyright notice(s) included with the software, who shall be authorized to hold Customer responsible for any copyright infringement or violation of this License Agreement.

Transfer of Rights in Software

Customer may transfer rights in the software to a third party only as part of the transfer of all their rights and only if Customer obtains the prior agreement of the third party to be bound by the terms of the License Agreement.

Upon such transfer, Customer agrees that the rights in the software are terminated and that they will either destroy their copies and adaptations or deliver them to the third party.

Transfer to a U.S. government department or agency or to a prime or lower tier contractor in connection with U.S. government contract shall be made only upon their prior written agreement to terms required by HP.

Sublicensing and Distribution

Customer may not sublicense the software or distribute copies or adaptations of the software to the public in physical media or by telecommunication without the prior written consent of HP.

Reference

Introduction

The following text gives an explanation of Q factor measurement techniques.

What is Q-factor?

The Q-factor is a figure of merit used to describe the signal-to-noise ratio of optically amplified transmission systems. The Q-factor is rapidly being adopted as a figure of merit for optically amplified communications systems because it provides an estimate of the signal-to-noise ratio at the receiver's decision circuit.

Derivation of Q

Quantitatively, the system performance is characterized by the bit error ratio (BER). This is the probability that a data pulse is interpreted incorrectly (i.e. a pulse signifying a '1' being detected as a '0' and vice versa). This may be understood with reference to figure 1a, which shows a portion of a typical fluctuating signal received by decision circuit, sampled at decision instant t_d . Figure 1b shows the probability density functions associated with the two logical states. The width of the distributions for the two logical states is determined by the source characteristics and the transmission impairments. Some of the causes of transmission impairments include amplified spontaneous emission (ASE), fiber chromatic dispersion, polarization mode dispersion, fiber non-linearity and noise in the receiver.

The sampled value, v , fluctuates from bit to bit around an average value μ_1 or μ_0 , depending on whether the received bit corresponds to a '1' or '0' respectively. The decision circuit compares the sampled value with a threshold value v_d , set somewhere between the two states. The decision circuit assigns a '1' if $v > v_d$ or a '0' if $v < v_d$.

An error occurs due to signal degradation if $v < v_d$ for a '1' or if $v > v_d$ for a '0'. The BER is determined as the sum of the areas under the tails of the probability density functions that appear on the wrong side of the decision threshold value v_d [shaded area in figure 1b]. The error probability or BER is:

$$\text{BER} = p(1) P(0/1) + p(0) P(1/0) \quad (1)$$

Where $p(1)$ and $p(0)$ are the probabilities of receiving '1' and '0' respectively. $P(0/1)$ is the probability of deciding '0' when '1' is received, and $P(1/0)$ is the probability of deciding '1' when '0' is received. Typical live signal traffic in a communications channel can be approximated by a pseudo random bit sequence (PRBS), where a '1' or '0' are equally likely to occur therefore $p(1) \approx p(0) = 1/2$. The BER can therefore be simplified to:

$$\text{BER} = 1/2[P(0/1) + P(1/0)] \quad (2)$$

Figure 1b illustrates $P(0/1)$ and $P(1/0)$ the probability density functions for a PRBS signal. These are approximately Gaussian, centered at the average signal levels μ_1 and μ_0 . The shaded region, where the distributions overlap, shows the probability of incorrect identification when μ_1 falls below v_d , or μ_0 exceeds v_d .

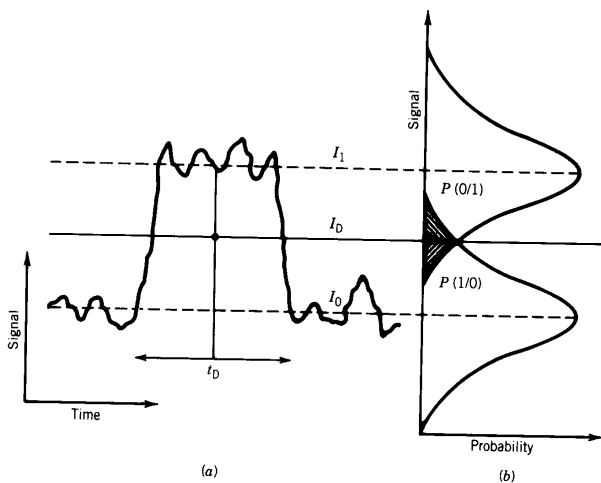

Figure 1. Typical signal appearing at the receiver decision circuit.

The probability density functions of μ_0 and μ_1 depend on the statistics of the noise sources responsible for variations in the received bits. A common approximation is to consider them as Gaussian probability density functions. As the mean and variance are, in general, different for a '1' and a '0', we define the corresponding variances as σ_1 and σ_0 respectively. For a Gaussian probability density function, the probabilities are:

$$P(0/1) = \frac{1}{\sigma_1 \sqrt{2\pi}} \int \exp\left[-\frac{(v_d - \mu_1)^2}{2\sigma_1^2}\right] d\mu = \text{erfc}\left(\frac{\mu_1 - v_d}{\sigma_1}\right) \quad (3)$$

$$P(1/0) = \frac{1}{\sigma_0 \sqrt{2\pi}} \int \exp\left[-\frac{(\mu - v_d)^2}{2\sigma_0^2}\right] d\mu = \text{erfc}\left(\frac{v_d - \mu_0}{\sigma_0}\right) \quad (4)$$

where erfc stands for the complimentary error function, and can be approximated as :

$$\text{erfc}(x) = \frac{1}{x\sqrt{2\pi}} \exp \frac{-x^2}{2} \quad (5)$$

Substituting in (2), the BER is given by:

$$\text{BER} = \frac{1}{2} \left[\text{erfc} \left(\frac{\mu_1 - v_d}{\sigma_1} \right) + \text{erfc} \left(\frac{v_d - \mu_0}{\sigma_0} \right) \right] \quad (6)$$

This equation shows that the BER depends on the decision threshold v_d . Choosing the decision point at the crossing point of the two probability density functions gives the lowest BER. In practice v_d is adjusted such that

$$\frac{(\mu_1 - v_d)}{\sigma_1} = \frac{(v_d - \mu_0)}{\sigma_0} \quad (7)$$

$$\text{hence } v_d = \frac{\sigma_0 \mu_1 + \sigma_1 \mu_0}{\sigma_0 + \sigma_1} \quad (8)$$

where Q is defined from equations (7) and (8) as:

$$Q = \frac{\mu_1 - \mu_0}{\sigma_1 + \sigma_0} \quad (9)$$

The BER with optimum decision threshold is given by:

$$\text{BER} = \frac{\exp - (Q^2 / 2)}{Q\sqrt{2\pi}} \quad (10)$$

The following graph illustrates how BER varies with the Q value.

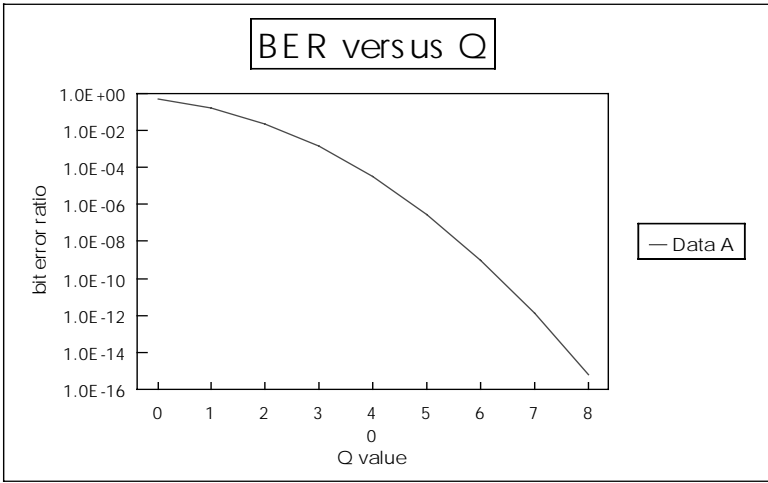

Figure 2: bit error ratio versus Q-factor

Measurements method

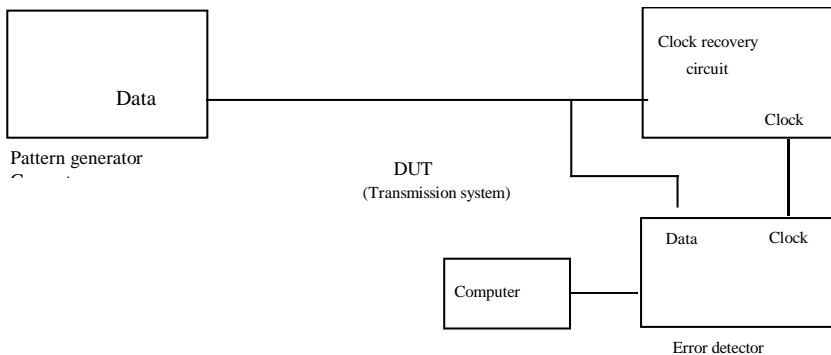

Figure 3 Block Diagram of variable decision threshold technique

The Q-factor is calculated from recorded data of BER versus decision level through the center of the data signal eye (ref. figure 4). The equivalent mean and variance of the 1's and 0's are determined by fitting this data to a Gaussian characteristic as per equation 6.

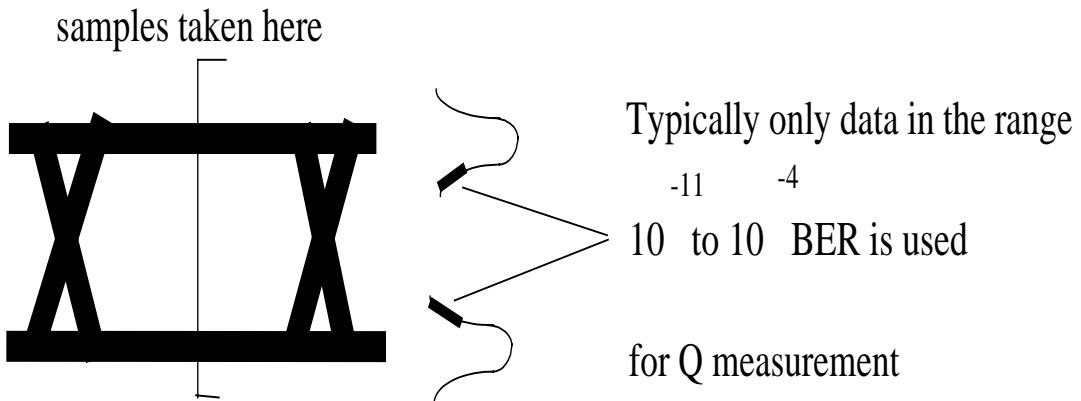

Figure 4: Data eye diagram indicating that the actual data is obtained from the tail of the Gaussian distributions

Because the probability density functions are not Gaussian, this technique implies that the calculated means and variances do not correlate exactly with the physical values that are to be found in the eye diagram, as in figure 1. They have, however, been shown¹ to be realistic values when used to predict the Q value.

The data for the '1's' and '0's' are separated into two sets separated by the point of minimum error ratio for measurable BERs, or by a decision level that yields error free performance. The Q-factor is determined from both sets of data.

The 0/1-threshold level (i.e. decision level) of an error performance analyzer is approximately set to the mean data '1' level, and the BER measured. The 0/1-threshold level is decreased by a small amount and the BER measured again. This process is repeated many times until a set of BER versus 0/1 threshold levels has been recorded (typically $10^{-4} < \text{BER} < 10^{-11}$). When measuring the Q-factor, it is normal to extend the measurement range beyond the range of values that will be used in the Q calculations to ensure that the data is not tailing off, as such a response may indicate a BER floor. Note that the 0/1-threshold level step size used provides a trade-off between the time taken to perform the measurement and the accuracy of the resulting Q value. For high Q systems the BER decreases quickly as the 0/1-threshold level tends towards the center of the eye therefore the step size employed should be small.

The 0/1-threshold level of the error performance analyzer is then approximately set to the mean data '0' level, and the BER measured. The 0/1-threshold level is increased by a small amount and the BER measured again. This process is repeated until a set of BER versus 0/1 threshold levels has been recorded (typically $10^{-4} < \text{BER} < 10^{-11}$).

The inverse error function is computed for each BER using the following approximation:

$$\left[\log\left(\frac{1}{2} \operatorname{erfc}(\cdot)\right)\right]^{-1}(x) \approx 1.192 - 0.6681x - 0.0162x^2 \quad \text{where } x \text{ is } \log(\text{BER}) \quad (11)$$

After evaluating the inverse error function, the data is plotted against the 0/1 threshold (i.e. decision) level, v_d . Each set of data should approximate to a straight line. A straight line is fitted to each set of data by linear regression . The equivalent variance and mean for the Q calculation are given by the slope and intercept.

Q is then calculated using equation (9).

References

1. N. S. Bergano, F. W. Kerfoot and C. R. Davidson, "Margin Measurements in Optical Amplifier Systems", IEEE Technology Letters, Vol. 5, No. 3, March 1993.
2. D. Marcuse, "Derivation of analytical expressions for the bit-error probability in lightwave systems with optical amplifiers", Journal of Lightwave Technology, Vol. 8, Dec 1990.
3. V.J. Mazurczyk, D.G. Duff, "Effect of intersymbol interference on signal-to-noise measurements", OFC '95 Technical Digest, vol. 8.
4. J.C Feggler et al, "WDM Transmission Measurements on an Installed Optical Undersea Cable System", Optical Fiber Conference, paper TuN3, San Jose, CA, Feb 27, 1996.